



*Take the Lead*

# Ice Machines

Under Counters  
Modulars  
Storage Bins  
Flake & Nuggets  
Snow Flake  
Dispensers  
Water Treatments



## ICE TYPE

### BELL/GOURMET

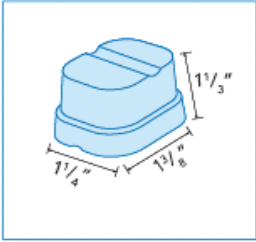

### CUBE

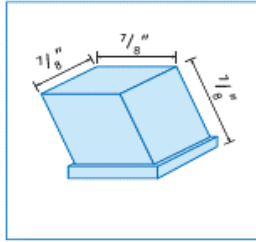

### HALF CUBE

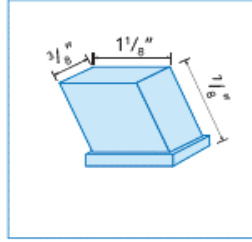

### FLAKE



### NUGGET

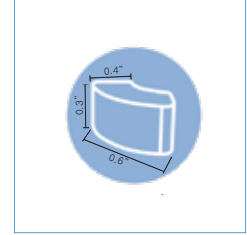

## MODEL NUMBERS

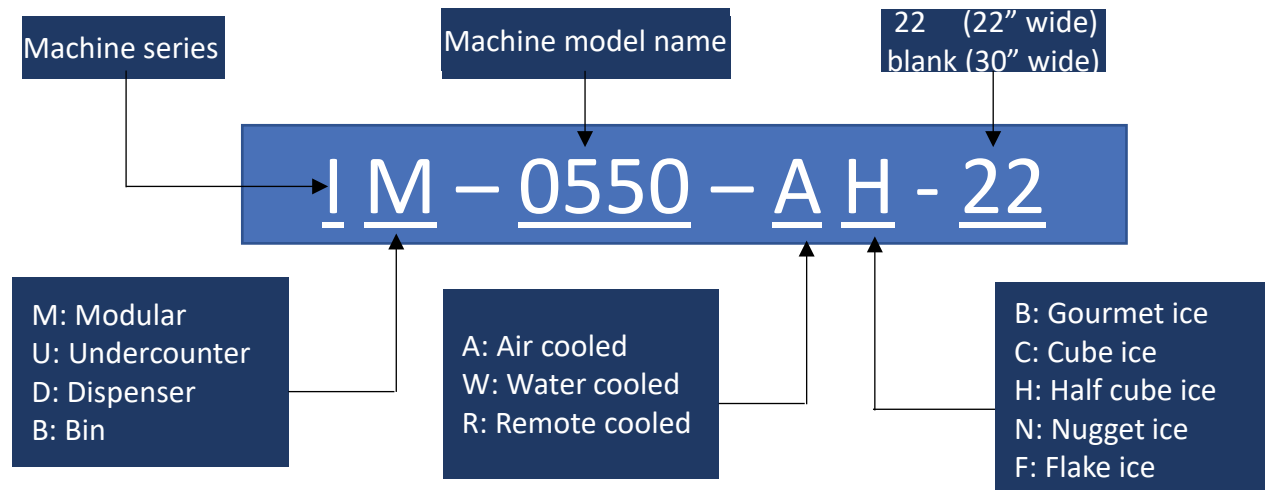

## COMMERCIAL WARRANTY

### Ice machines - Undercounter, Modulars

- 3 Years Parts & Labor
- 5 Years Parts & Labor for evaporator
- 5 Years Parts & 3 Years Labor for compressor

### Ice storage bins

- 3 Years Parts & Labor
- 1 Year Parts & Labor for IB-M900-48 (effective 02/01/2021)

### Ice machines - Flake/Nugget, Ice/Water Dispensers, Hotel Dispensers

- 3 Years Parts & Labor
- 5 Years Parts & 3 Years Labor for compressor

\* Residential Warranty: all Ictro equipment, if installed in residential area

- 1 Year Parts & Labor

# UNDER COUNTER AIR COOLED

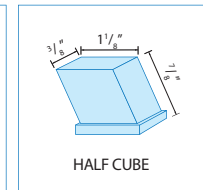
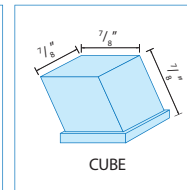
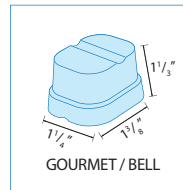

## IU-0070

\* Replace WU-0070

MODEL	STORAGE CAPACITY	DIMENSION (WxDxH)	WEIGHT	ICE SHAPE
	lbs	inch	lbs (Net / Shipping)	
IU-0070-OU	26	15 x 25 x 34	104 / 110	GOURMET/ BELL
CONDENSER	ELECTRICAL OPTIONS	Power (kWh/100 lbs ice)	Air / Water 70°F / 50°F	Air / Water 90°F / 70°F
Air Cooled	115 V/60 Hz/1 Ph	11.15	60 lbs	48 lbs

Optional drain pump kit: IPK-56 (AC motor drain pump kit), IPK-60B (DC motor drain pump kit)



\* FWU-0100R

## WU-0100

MODEL	STORAGE CAPACITY	DIMENSION (WxDxH)	WEIGHT	ICE SHAPE
	lbs	inch	lbs (Net / Shipping)	
WU-0100-AC	27	21 x 23 x 35	110 / 125	CUBE
CONDENSER	ELECTRICAL OPTIONS	Power (kWh/100 lbs ice)	Air / Water 70°F / 50°F	Air / Water 90°F / 70°F
Air Cooled	115 V/60 Hz/1 Ph	9.39	105 lbs	74 lbs

\* FWU-0100R: Replacement water Filter (1 unit included)

A filter is required for this machine to operate. If your machine stops producing ice, it is likely time to replace the filter.



## IU-0170

MODEL	STORAGE CAPACITY	DIMENSION (WxDxH)	WEIGHT	ICE SHAPE
	lbs	inch	lbs (Net / Shipping)	
IU-0170-AC	77	26 x 28 x 39	154 / 183	CUBE
IU-0170-AH				HALF CUBE
CONDENSER	ELECTRICAL OPTIONS	Power (kWh/100 lbs ice)	Air / Water 70°F / 50°F	Air / Water 90°F / 70°F
Air Cooled	115 V/60 Hz/1 Ph	8.62	175 lbs	150 lbs



## IU-0220

MODEL	STORAGE CAPACITY	DIMENSION (WxDxH)	WEIGHT	ICE SHAPE
	lbs	inch	lbs (Net / Shipping)	
IU-0220-AC	77	26 x 28 x 39	154 / 183	CUBE
IU-0220-AH				HALF CUBE
CONDENSER	ELECTRICAL OPTIONS	Power (kWh/100 lbs ice)	Air / Water 70°F / 50°F	Air / Water 90°F / 70°F
Air Cooled	115 V/60 Hz/1 Ph	8.62	202 lbs	150 lbs

# MODULAR (30") AIR COOLED

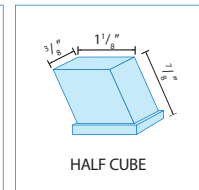
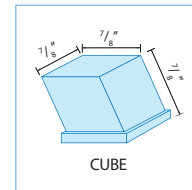

## IM-0350

MODEL	STORAGE BIN OPTION	DIMENSION (WxDxH)	WEIGHT	ICE SHAPE
		inch	lbs (Net / Gross)	
IM-0350-AC	IB-033 / IB-044	30 x 25 x 23	152.1 / 171	CUBE
IM-0350-AH				HALF CUBE
CONDENSER	ELECTRICAL OPTIONS	Power (kWh / 100 lbs ice)	Air / Water 70°F / 50°F	Air / Water 90°F / 70°F
Air Cooled	115 V/60 Hz/1 Ph	6.25	367 lbs	292 lbs



## IM-0460

\* Replace WM-0460

MODEL	STORAGE BIN OPTION	DIMENSION (WxDxH)	WEIGHT	ICE SHAPE
		inch	lbs (Net / Gross)	
IM-0460-AC	IB-033 / IB-044	30 x 25 x 23	162.3 / 184	CUBE
IM-0460-AH				HALF CUBE
CONDENSER	ELECTRICAL OPTIONS	Power (kWh / 100 lbs ice)	Air / Water 70°F / 50°F	Air / Water 90°F / 70°F
Air Cooled	115 V/60 Hz/1 Ph	5.43	444 lbs	364 lbs



## IM-0550

MODEL	STORAGE BIN OPTION	DIMENSION (WxDxH)	WEIGHT	ICE SHAPE
		inch	lbs (Net / Gross)	
IM-0550-AC	IB-033 / IB-044	30 x 25 x 23	162.3 / 189	CUBE
IM-0550-AH				HALF CUBE
CONDENSER	ELECTRICAL OPTIONS	Power (kWh / 100 lbs ice)	Air / Water 70°F / 50°F	Air / Water 90°F / 70°F
Air Cooled	115 V/60 Hz/1 Ph	5.91	551 lbs	399 lbs



## IM-0750

\* Replace WM-0680 & IM-0680

MODEL	STORAGE BIN OPTION	DIMENSION (WxDxH)	WEIGHT	ICE SHAPE
		inch	lbs (Net / Gross)	
IM-0750-AC	IB-033 / IB-044 / IB-M900-48	30 x 25 x 23	185.2 / 218	CUBE
IM-0750-AH				HALF CUBE
CONDENSER	ELECTRICAL OPTIONS	Power (kWh / 100 lbs ice)	Air / Water 70°F / 50°F	Air / Water 90°F / 70°F
Air Cooled	208~230 V/60 Hz/1 Ph	5.59	737 lbs	575 lbs



## IM-1100

\* Replace WM-1100

MODEL	STORAGE BIN OPTION	DIMENSION (WxDxH)	WEIGHT	ICE SHAPE
		inch	lbs (Net / Gross)	
IM-1100-AC	IB-044 / IB-M900-48	30 x 25 x 30	231.5 / 262	CUBE
IM-1100-AH				HALF CUBE
CONDENSER	ELECTRICAL OPTIONS	Power (kWh / 100 lbs ice)	Air / Water 70°F / 50°F	Air / Water 90°F / 70°F
Air Cooled	208~230 V/60 Hz/1 Ph	4.99	1106 lbs	873 lbs

# MODULAR (30") WATER COOLED

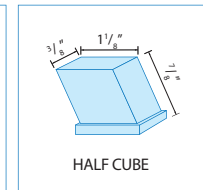
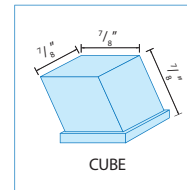

## IM-0460

MODEL	STORAGE BIN OPTION	DIMENSION (WxDxH)	WEIGHT	ICE SHAPE
		inch	lbs (Net / Gross)	
IM-0460-WC	IB-033 / IB-044	30 x 24.8 x 22.6	159.8 / 192	CUBE
IM-0460-WH				HALF CUBE
CONDENSER	ELECTRICAL	Power (kWh/100 lbs ice)	Air / Water 70°F / 50°F	Air / Water 90°F / 70°F
Water Cooled	115 V/60 Hz/1 Ph	4.56	463 lbs	407 lbs



## IM-0550

MODEL	STORAGE BIN OPTION	DIMENSION (WxDxH)	WEIGHT	ICE SHAPE
		inch	lbs (Net / Gross)	
IM-0550-WC	IB-033 / IB-044	30 x 24.8 x 22.6	159.8 / 192	CUBE
IM-0550-WH				HALF CUBE
CONDENSER	ELECTRICAL	Power (kWh/100 lbs ice)	Air / Water 70°F / 50°F	Air / Water 90°F / 70°F
Water Cooled	115 V/60 Hz/1 Ph	4.53	547 lbs	483 lbs



## IM-1100

MODEL	STORAGE BIN OPTION	DIMENSION (WxDxH)	WEIGHT	ICE SHAPE
		inch	lbs (Net / Gross)	
IM-1100-WC	IB-044 / IB-M900-48	30 x 24.8 x 30.3	216 / 255	CUBE
IM-1100-WH				HALF CUBE
CONDENSER	ELECTRICAL	Power (kWh/100 lbs ice)	Air / Water 70°F / 50°F	Air / Water 90°F / 70°F
Water Cooled	208~230 V/60 Hz/1 Ph	4.13	1036 lbs	1004 lbs

# MODULAR (30") REMOTE AIR COOLED

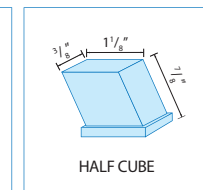
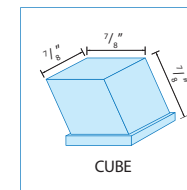

## IM-1100

MODEL	STORAGE BIN OPTION	DIMENSION (WxDxH)	WEIGHT	ICE SHAPE
		inch	lbs (Net / Shipping)	
IM-1100-RC	IB-044 / IB-M900-48	30 x 24.8 x 30.3	216 / 255	CUBE
IM-1100-RH				HALF CUBE
CONDENSER	ELECTRICAL	Power (kWh/100 lbs ice)	Air / Water 70°F / 50°F	Air / Water 90°F / 70°F
Remote Air Cooled	208~230 V/60 Hz/1 Ph	4.72	1081 lbs	949 lbs



## Condensing Unit (pre-charged)

MODEL	ELECTRICAL	DIMENSION (WxDxH)	WEIGHT
		inch	lbs (Net / Shipping)
IRC-1100	wired to machine head (50' power cable included with each line-set)	22.6 x 35.6 x 27.1	80 / 105

## Tubing (pre-charged)



IRT-20R404A (20ft with Quick connects)  
IRT-35R404A (35ft with Quick connects)  
IRT-50R404A (50ft with Quick connects)

# MODULAR (22") AIR COOLED

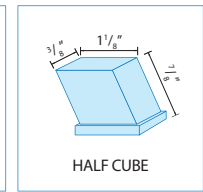
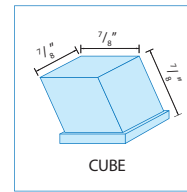

## IM-0350-22

MODEL	STORAGE BIN OPTION	DIMENSION (WxDxH)	WEIGHT	ICE SHAPE
		inch	lbs (Net / Shipping)	
IM-0350-AC-22	IB-026-22 / IB-033	22 x 24.8 x 22.6	138.9 / 163	CUBE
IM-0350-AH-22				HALF CUBE
CONDENSER	ELECTRICAL	Power (kWh/100 lbs ice)	Air / Water 70°F / 50°F	Air / Water 90°F / 70°F
Air Cooled	115 V/60 Hz/1 Ph	6.27	394 lbs	311 lbs



## IM-0460-22

\* Replace WM-0460-22

MODEL	STORAGE BIN OPTION	DIMENSION (WxDxH)	WEIGHT	ICE SHAPE
		inch	lbs (Net / Shipping)	
IM-0460-AC-22	IB-026-22 IB-033/ IB-044	22 x 24.8 x 22.6	143.3 / 168	CUBE
IM-0460-AH-22				HALF CUBE
CONDENSER	ELECTRICAL	Power (kWh/100 lbs ice)	Air / Water 70°F / 50°F	Air / Water 90°F / 70°F
Air Cooled	115 V/60 Hz/1 Ph	6.21	443 lbs	327 lbs



## IM-0550-22

MODEL	STORAGE BIN OPTION	DIMENSION (WxDxH)	WEIGHT	ICE SHAPE
		inch	lbs (Net / Shipping)	
IM-0550-AC-22	IB-026-22 IB-033 / IB-044	22 x 24.8x 22.6	143.3 / 171	CUBE
IM-0550-AH-22				HALF CUBE
CONDENSER	ELECTRICAL	Power (kWh/100 lbs ice)	Air / Water 70°F / 50°F	Air / Water 90°F / 70°F
Air Cooled	115 V/60 Hz/1 Ph	6.08	508 lbs	383 lbs



IM-0460-AH-22 shown with IB-026-22

# FLAKE & NUGGET 22" MODULAR

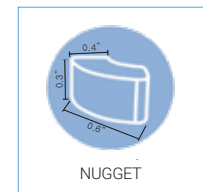

## IM-0770

MODEL	STORAGE BIN OPTION	DIMENSION (WxDxH)	WEIGHT	ICE SHAPE	
		inch	lbs (Net / Shipping)		
IM-0770-AF	IB-026-22 / IB-033 / IB-044 / IB-M900-48	22 x 25 x 26	174 / 201	FLAKE	
IM-0770-AN				NUGGET	
CONDENSER		ELECTRICAL	Power (kWh/100 lbs ice)	Air / Water 70°F / 50°F	Air / Water 90°F / 70°F
Air Cooled		115 V/60 Hz/1 Ph	5.18 / 5.43	736 / 708 lbs	639 / 635 lbs

- ✓ 22" SLIM DESIGN
- ✓ ADOPTED SLEEVE BEARING FOR HYGIENE IMPROVEMENT



IM-0770-AN  
shown with IB-026-22



# NUGGET UNDER COUNTER

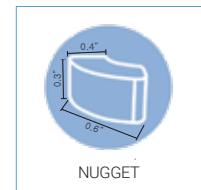

## IU-0090

	STORAGE CAPACITY	DIMENSION (WxDxH)	WEIGHT	ICE SHAPE	
	lbs	inch	lbs (Net / Gross)		
IU-0090-AN	24.3	15 x 22 x 34	112 / 187	NUGGET	
*IU-0090-ANP					
CONDENSER		ELECTRICAL	Power (kWh/100 lbs ice)	Air / Water 70°F / 50°F	Air / Water 90°F / 70°F
Air Cooled		115 V/60 Hz/1 Ph	10.58	91 lbs	67 lbs

\* IU-0090ANP has built-in DC motor drain pump.

# SNOW FLAKE FLOOR



## IS-0700

MODEL	PRODUCTION CAPACITY (MILK)		PRODUCTION CAPACITY (WATER)	STORAGE CAPACITY
	lbs		lbs	gal
IS-0700-AS	1091		705	14
CONDENSER		ELECTRICAL	DIMENSION (WxDxH)	WEIGHT
Air Cooled		208~230 V/60 Hz/1 Ph	21 x 30 x 56	335 / 392

- ✓ ADOPTED THE FREEZE CYCLE APPLIED ON SOFT ICE CREAM FREEZER
- ✓ BEST DESIGN FOR HYGIENE IMPROVEMENT & EASY MAINTENANCE
- ✓ WORLD STANDARD OF SNOW FLAKE ICE MACHINE



# ICE STORAGE BIN



## IB-026-22

MODEL	APPLICABLE	STORAGE CAPACITY	DIMENSION (WxDxH)	WEIGHT
		lbs	inch	lbs (Net / Shipping)
IB-026-22	IM-0350/22 IM-0460/22 IM-0550/22 IM-0770	265	22 x 34 x 38 (Without legs)	99 / 113



## IB-033

MODEL	APPLICABLE	STORAGE CAPACITY	DIMENSION (WxDxH)	WEIGHT
		lbs	inch	lbs (Net / Shipping)
IB-033	IM-0350/22 IM-0460/22 IM-0550/22 IM-0680 IM-0750 IM-0770	350	30 x 34 x 38 (Without legs)	121 / 140

※ Bin top adapter needed to use 22" Ice Machine Head  
 1) IBT-2230R: 8" Bin Top Adapter to left mount 22" Head on IB-033  
 2) IBT-2230BV: (2) 4" Bin Top Adapter to center mount 22" Head on IB-033



## IB-044

MODEL	APPLICABLE	STORAGE CAPACITY	DIMENSION (WxDxH)	WEIGHT
		lbs	inch	lbs (Net / Shipping)
IB-044	IM-0460/22 IM-0550/22 IM-0680 IM-0750 IM-0770 IM-1100	440	30 x 34 x 46 (Without legs)	143 / 167

※ Bin top adapter needed to use 22" Ice Machine Head  
 1) IBT-2230R: 8" Bin Top Adapter to left mount 22" Head on IB-033  
 2) IBT-2230BV: (2) 4" Bin Top Adapter to center mount 22" Head on IB-033



## IB-M900-48

MODEL	APPLICABLE	STORAGE CAPACITY	DIMENSION (WxDxH)	WEIGHT
		lbs	inch	lbs (Net / Shipping)
IB-M900-48	IM-0680 IM-0750 IM-0770 IM-1100	900	48 x 31 x 44 (Without legs)	210 / 305

※ Bin top adapter included to center mount 30" Ice Machine Head,  
 and prior request necessary to use 22" Head when place order



## 1045 Upright

MODEL	APPLICABLE	STORAGE CAPACITY	DIMENSION (WxDxH)	WEIGHT
		lbs	inch	lbs (Net / Shipping)
1045-SS	IM-0750 IM-0770 IM-1100	1,061	48 x 44.5 x 44	210 / 300

※ Universal bin top adapter included to center mount 30" & 22" Ice Machine Head,



# ICE / WATER DISPENSER

Three Modes  
(ICE / WATER / ICE & WATER)

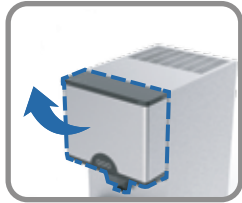

Swing Front Door



ID-0300-AN

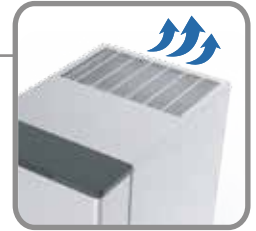

Air Discharge on Top



UV Sterilization  
- Detachable inner chute for cleaning and sterilization



## ID-0160

MODEL	STORAGE CAPACITY		DIMENSION (WxDxH)	WEIGHT	ICE SHAPE
	lbs		inch (without foot)	lbs (Net / Gross)	
ID-0160-AN	5.3		13.8 x 23.8 x 24.8	106 / 112.	NUGGET
CONDENSER	ELECTRICAL OPTIONS	Power (kWh / 100 lbs ice)	Air / Water 21°C(70°F) / 10°C(50°F)	Air / Water 32°C(90°F) / 21°C(70°F)	
Air Cooled	115V/60Hz/1Ph	6.5	160 lbs	106 lbs	



## ID-0300

MODEL	STORAGE CAPACITY		DIMENSION (WxDxH)	WEIGHT	ICE SHAPE
	lbs		inch (without foot)	lbs (Net / Gross)	
ID-0300-AN	11		16.6 x 25 x 27.9	145.5 / 178	NUGGET
CONDENSER	ELECTRICAL OPTIONS	Power (kWh / 100 lbs ice)	Air / Water 21°C(70°F) / 10°C(50°F)	Air / Water 32°C(90°F) / 21°C(70°F)	
Air Cooled	115V/60Hz/1Ph	6.5	282 lbs	206 lbs	



## ID-0450

MODEL	STORAGE CAPACITY		DIMENSION (WxDxH)	WEIGHT	ICE SHAPE
	lbs		inch (without foot)	lbs (Net / Gross)	
ID-0450-AN	30		16.6 x 26.5 x 43.1	203 / 223	NUGGET
CONDENSER	ELECTRICAL OPTIONS	Power (kWh / 100 lbs ice)	Air / Water 21°C(70°F) / 10°C(50°F)	Air / Water 32°C(90°F) / 21°C(70°F)	
Air Cooled	115V/60Hz/1Ph	7.28	378 lbs	289 lbs	

※ Design and Specification are subject to change without notice

# HOTEL / MOTEL ICE DISPENSER



## ID-H150

MODEL	STORAGE CAPACITY lbs	DIMENSION (WxDxH) inch (with 6" legs)	WEIGHT lbs (Net / Gross)
ID-H150-22	141	22.5" x 33.3" x 51.5"	187 / 209

\* IDH-WKIT: option kit for water supply



## ID-H250

MODEL	STORAGE CAPACITY lbs	DIMENSION (WxDxH) inch (with 6" legs)	WEIGHT lbs (Net / Gross)
ID-H250-30	247	30" x 33.3" x 51.5"	207 / 229

\* IDH-WKIT: option kit for water supply



ID-H150-22 shown with IM-0550-AH-22  
(Ice machine sold separately)



ID-H250-30 shown with IM-0550-AH  
(Ice machine sold separately)

# ICEPRO SERIES WATER TREATMENT

## FOR ICETRO AMERICA ICE MAKERS

The new IcePro series incorporate advanced water treatment technology and is manufactured with completely environmentally friendly components. The IcePro series will provide superior filtration to remove particulates and eliminate the effects of hard water scale in all ICETRO ice makers.



ICETRO America utilize the IcePro water treatment systems in providing with pre-filtration to all of our systems as well as controlling scales with a patent blend called Citryne\*. The IcePro series is a complete system without the need to add additional pre-filtration or scale control.

	Description	Flow Rate	Fittings
IcePro 400	Ice makers up to 400 lbs	2.8 GPM	1/2" FNPT
IcePro 800	Ice makers up to 800 lbs	3.5 GPM	1/2" FNPT
IcePro 1300	Ice makers up to 1300 lbs	5.5 GPM	1/2" FNPT
IcePro DIS	Ice/Water Dispensers	1.0 GPM	3/8" Flare comp.



IcePro DIS



IcePro 400



IcePro 800



IcePro 1300



ICETROAMERICA.COM



## A BRAND THAT STANDS FOR QUALITY AND VALUE

The ICETRO team is committed to providing high-performance frozen food equipment products not only to satisfy our customers' need but add value to the equipment investment.

ICETRO America strives to build long-lasting high-quality products that deliver the best value in creating COOL HAPPINESS to our valuable customers.

We aim to continue as the leading provider of high-quality frozen food equipment through continuous improvements in SIMPLICITY of design, product RELIABILITY & LONGEVITY, and superior PERFORMANCE.



SIMPLICITY



RELIABILITY



LONGEVITY



PERFORMANCE



Revised 08/11/2022



1565 West Broadway, Anaheim, CA 92802  
Tel: (714) 215- 4864

6432 Warren Drive, Norcross, GA 30093  
Tel: (470) 567 - 8603

Website: [www.icetroamerica.com](http://www.icetroamerica.com)  
e-mail: [icetro@icetroamerica.com](mailto:icetro@icetroamerica.com)  
Service call: (470) 567 - 8693

Distributed by :

